

1 JAMB DETAIL
SCALE: FULL
HEAD and SILL SIMILAR

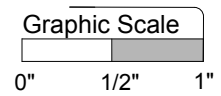
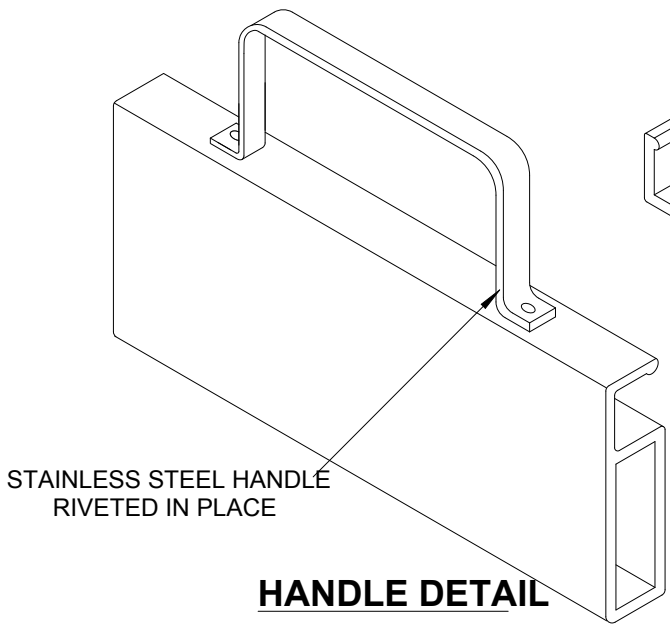
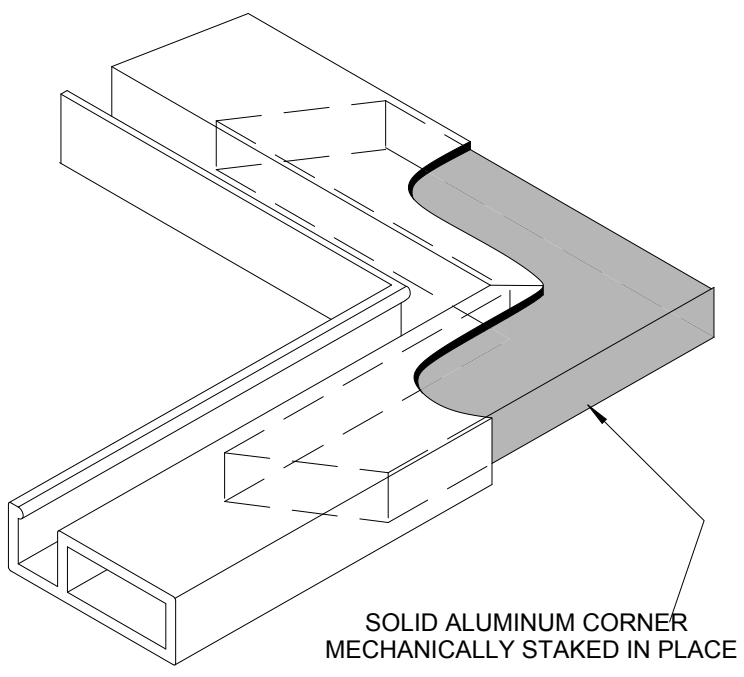
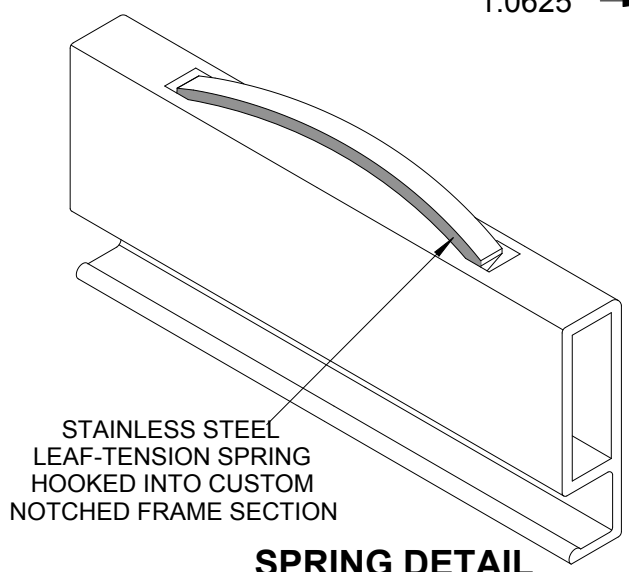

PRODUCT
SCREEN
S-101 FRAMING

DWG. NO.
1-2

Allied Window
Performance Panels™